

iBKS Plus Datasheet



ABSTRACT

iBKS Plus Technical Data

AUDIENCE

This document is primarily focused for engineers or other users with a technical profile

FEATURES

- Advertising **Beacon** Device
- **Bluetooth Low Energy®**
- Full **Eddystone** & **iBeacon** compatible
- 100% Configurable Parameters
- Firmware update **Over The Air** (OTA)
- Dust & Waterproof performance: **IP67** Certified
- External button to enable/disable and configure with a status LED
- Provided with your own configuration (MOQ 50 units)
- Screws/ flanges/ sticker for deploying
- Additional optional sensors available
- **FCC** & **CE** Certifications

Revision 6 | March 2018

Table of Contents

FCC Statement.....	2
1. Specifications.....	4
2. iBKS Plus Mechanical Draws.....	5
3. Button Functionality	5
3.1 Turn ON iBKS Plus.....	6
3.2 Turn OFF iBKS Plus.....	7
4. Battery Life Estimation	8
4.1 Estimation Scope.....	8
4.2 Common Use Cases.....	8
4.3 Battery life estimation for iBKS Plus Alkaline.....	9
4.4 Battery life estimation for iBKS Plus Lithium	10
5. RX Power (dBm) vs Distance.....	11
Revision History	13

FCC Statement

This device complies with Part 15 of the FCC Rules. Operation is subject to the following two conditions: (1) this device may not cause harmful interference, and (2) this device must accept any interference received, including interference that may cause undesired operation.

FCC Caution:

Changes or modifications not expressly approved by the part responsible for compliance could void the user's authority to operate the equipment.

FCC Statement:

"This equipment has been tested and found to comply with the limits for a Class B digital device, pursuant to part 15 of the FCC Rules. These limits are designed to provide reasonable protection against harmful interference in a residential installation. This equipment generates, uses and can radiate radio frequency energy and, if not installed and used in accordance with the instructions, may cause harmful interference to radio communications. However, there is no guarantee that interference will not occur in a particular installation. If this equipment does cause harmful interference to radio or television reception, which can be determined by turning the equipment off and on, the user is encouraged to try to correct the interference by one or more of the following measures:

- Reorient or relocate the receiving antenna.
- Increase the separation between the equipment and receiver.
- Connect the equipment into an outlet on a circuit different from that to which the receiver is connected.
- Consult the dealer or an experienced radio/TV technician for help."

RSS-Gen & RSS-210 statement:

This device complies with Industry Canada licence-exempt RSS standard(s). Operation is subject to the following two conditions: (1) this device may not cause interference, and (2) this device must accept any interference, including interference that may cause undesired operation of the device.

Le présent appareil est conforme aux CNR d'Industrie Canada applicables aux appareils radio exempts de licence. L'exploitation est autorisée aux deux conditions suivantes : (1) l'appareil ne doit pas produire de brouillage, et (2)

l'utilisateur de l'appareil doit accepter tout brouillage radioélectrique subi, même si le brouillage est susceptible d'en compromettre le fonctionnement.

RSS-102 Statement:

This equipment complies with Industry Canada radiation exposure limits set forth for an uncontrolled environment.

Cet équipement est conforme à l'exposition aux rayonnements Industry Canada limites établies pour un environnement non contrôlé.

1. Specifications

This section contains electrical, mechanical and software specifications for iBKS Plus

Dimensions	84 x 84 x 24 mm	Case material	ABS
Weight	153g (Lithium) 182g (Alkaline)	Case finish	Matte white
Core	Nordic nRF51822	Button material	TPU
Radio Protocol	Bluetooth® Low Energy	Button finish	Matte black
Distance Range	Up to 100m	Fixing method	Double side sticker Screws Flanges
Battery	4 AA size	Operating Temperature	Related to battery type (see below)
Optional Sensors	Hall Accelerometer Temperature	Storage Temperature	Related to battery type (see below)
Firmware Update	OTA (Over The Air)	Beacon Protocols	iBeacon Eddystone: UID, URL, TLM & EID
Idle Current Consumption	3.5 to 3.8µA	Certifications	FCC, CE & IP67

Alkaline Battery

Battery Type	4 AA - 1.5V - 2700mAh	Operating Temperature	-20 to +54°C
Total Capacity	3V - 5400mAh	Storage Temperature	5 to 30°C

Lithium Battery

Battery Type	4 AA - 3.6V - 2600mAh	Operating Temperature	-40 to +85°C
Total Capacity	3.6V - 10400mAh	Storage Temperature	5 to 30°C

2. iBKS Plus Mechanical Draws

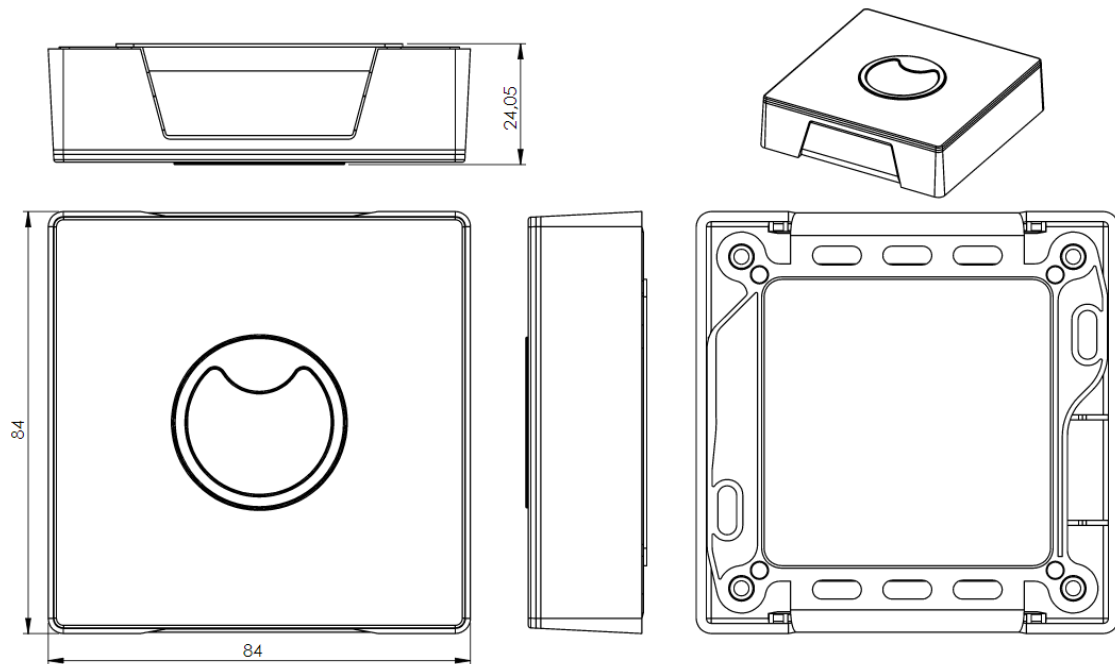

All dimensions in mm

3. Button Functionality

IMPORTANT:

This chapter applies from firmware version EDSTEID V5.2016.06.29.1 onwards.

By default, iBKS Plus comes from factory with batteries already installed. In order to avoid wasting energy, iBKS Plus is set to the off mode*.

*In the off mode, the Core is in sleep mode and the power consumption is rated to 3.5 μ A.

3.1 Turn ON iBKS Plus

1 Push button once



2 LED will start blinking for 30 seconds



- During these 30 seconds, the iBKS Plus is in connectable mode independently of the user mode configured. If the iBKS Plus is locked, the password will be also required to connect.

3 After 30 seconds, the iBKS entries in the user set mode.

3.2 Turn OFF iBKS Plus

1 Push button once



2 LED will stay on for 3 seconds



3 The iBKS entries in the off mode

- In this status, the core is in sleep mode and will remain until the user turn it on again. The power consumption in this mode is rated to 3.5 μA .

IMPORTANT:

If Eddystone EID frame is enabled, even the frame will not be advertised in this mode, the Core will wake up to keep the EID synchronization every defined period of time by the user through EID Rotation Period (K). In that case, the power consumption is rated to 3.8 μA .

4. Battery Life Estimation

IMPORTANT:

Battery life estimation applies from firmware version EDSTEID V5.2016.06.29.1 onwards.

Notice all values shown in this chapter are just an estimation. Real battery life might differ depending on the environment where the iBKS Plus is placed.

4.1 Estimation Scope

In order to estimate the battery life, the following configurable items have been considered:



























- Number of slots enabled
- Type of slot: iBeacon or Eddystone (UID, URL, TLM and EID)
- TX power defined for each slot
- Advertising period defined for each slot
- Beacon mode: connectable or non-connectable.

4.2 Common Use Cases

The common use cases shown in the table have been estimated under the following conditions:



























- All the slots enabled advertise at the same TX power.
- All the slots enabled, except Eddystone Telemetry (TLM), have the same advertising period: 950ms.
- The advertising period for Eddystone TLM is set to 60s.
- The iBKS is in always non-connectable mode.
- EID Rotation Period (K) is set to 10 which means that every 17 minutes approximately a new ephemeral ID is calculated.

4.3 Battery life estimation for iBKS Plus Alkaline

Slots Enabled	Tx Power (dBm)							
	-30	-20	-16	-12	-8	-4	0	+4
 iBeacon	91	91	90	88	88	87	84	77
 UID Eddystone	90	90	90	88	88	86	84	77
 URL Eddystone	90	90	90	88	88	86	84	77
 EID Eddystone	92	92	92	90	90	89	87	81
 iBeacon  TLM Eddystone	85	85	85	83	83	82	79	73
 iBeacon  URL Eddystone	69	69	68	66	66	64	61	55
 UID  TLM Eddystone Eddystone	85	85	84	83	83	81	79	73
 UID  URL Eddystone Eddystone	69	68	68	67	66	64	61	54
 URL  TLM Eddystone Eddystone	85	85	84	83	83	81	79	73
 EID  URL Eddystone Eddystone	70	70	69	67	67	66	63	56
 EID  TLM Eddystone Eddystone	92	87	86	86	85	84	81	76
 iBeacon  URL Eddystone	69	68	68	66	66	64	61	54
 TLM Eddystone								
 UID  URL Eddystone Eddystone	68	68	67	65	65	65	61	54
 TLM Eddystone								
 EID  URL Eddystone Eddystone	70	69	69	67	67	65	62	56
 TLM Eddystone								

Notes: Battery Life in months. Battery Capacity 4 x LR6 Alkaline: 5400mAh

4.4 Battery life estimation for iBKS Plus Lithium

Slots Enabled	Tx Power (dBm)							
	-30	-20	-16	-12	-8	-4	0	+4
 iBeacon	103	102	102	102	101	100	98	93
 UID Eddystone	102	102	102	101	101	100	98	93
 URL Eddystone	102	102	102	101	101	100	98	93
 EID Eddystone	104	104	103	103	102	101	100	96
  TLM Eddystone	99	99	99	98	97	97	95	90
  URL Eddystone	87	86	86	85	84	83	80	74
 UID  TLM Eddystone Eddystone	99	99	98	98	97	96	94	90
 UID  URL Eddystone Eddystone	86	86	86	85	84	83	80	74
 URL  TLM Eddystone Eddystone	99	99	98	98	97	96	94	90
 EID  URL Eddystone Eddystone	87	87	87	86	85	84	81	75
 EID  TLM Eddystone Eddystone	100	100	100	99	99	98	96	92
  URL Eddystone	86	86	86	85	84	83	80	74
 TLM Eddystone								
 UID  URL Eddystone Eddystone	86	86	85	85	84	82	80	73
 TLM Eddystone								
 EID  URL Eddystone Eddystone	87	87	86	86	85	84	81	75
 TLM Eddystone								

Notes: Battery Life in months. Battery Capacity 4 x LR6 Lithium: 10400mAh

5. RX Power (dBm) vs Distance

The following table and graph show the RX power received (dBm) in comparison with distance (m) for all configurable TX powers.

Distance (m)	TX Power (dBm)							
	-30	-20	-16	-12	-8	-4	0	+4
0	-52	-40	-38	-36	-34	-29	-26	-22
1	-90	-80	-78	-75	-73	-67	-59	-53
3	-95	-86	-81	-80	-79	-73	-67	-65
5	-99	-88	-86	-83	-81	-76	-73	-68
10	-102	-95	-88	-86	-84	-78	-75	-71
15		-97	-92	-91	-90	-88	-82	-78
20		-98	-94	-92	-91	-89	-85	-82
30		-99	-96	-93	-92	-91	-87	-84
40		-100	-98	-94	-94	-93	-89	-86
50		-102	-100	-97	-96	-95	-93	-90
60			-101	-98	-98	-97	-96	-91
70			-102	-101	-100	-99	-98	-92
80				-102	-101	-100	-98	-94
90					-102	-101	-99	-96
100						-102	-101	-100

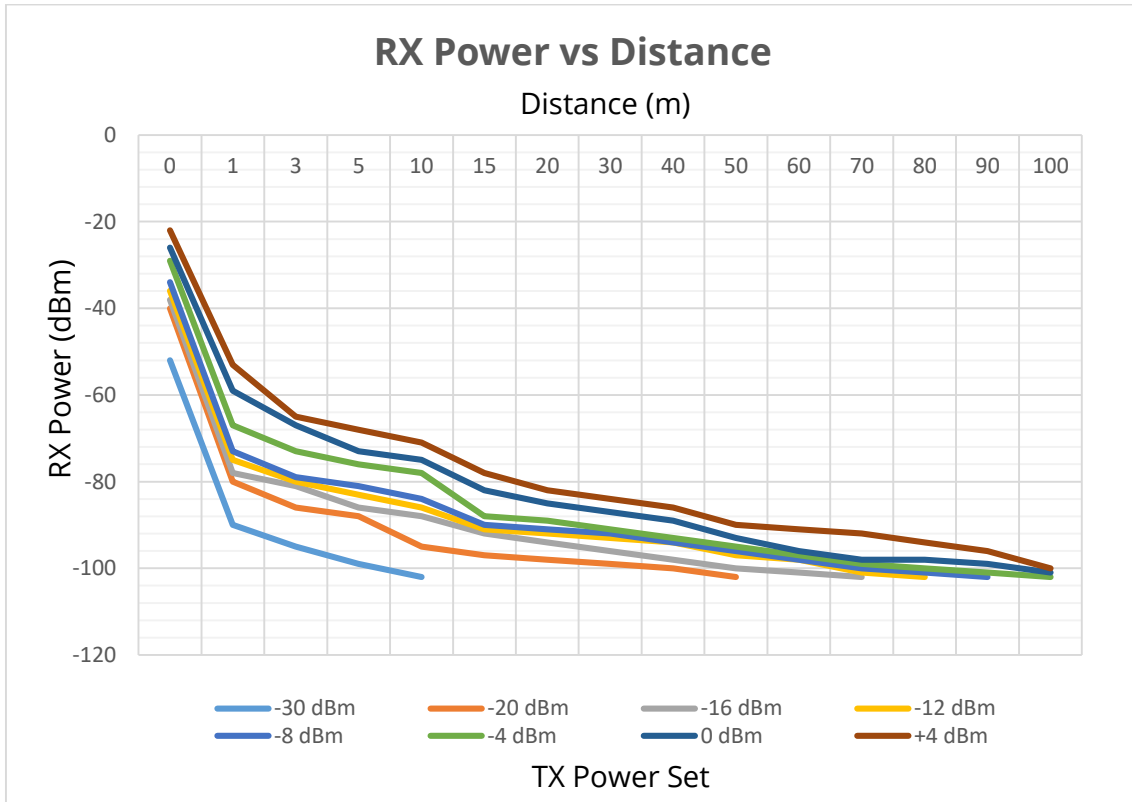

IMPORTANT:

This chapter applies from firmware version EDSTEID V5.2016.06.29.1 onwards.

Notice all values shown in this chapter have been tested in an open field of a city. Depending on the environment where the iBKS Plus is placed these values might differ.

Revision History

The following revision history table summarizes changes contained in this document.

Revision Number	Revision Date	Description of Changes
Rev 0	10/2015	Initial Release
Rev 1	08/2016	<ul style="list-style-type: none">☞ Design changed☞ Specifications updated☞ Added mechanical draws☞ Added button functionality☞ Added battery life estimation☞ Added RX Power vs Distance
Rev 2	09/2016	<ul style="list-style-type: none">☞ Battery life estimation values updated☞ Batteries capacity values updated
Rev 3	11/2016	<ul style="list-style-type: none">☞ Lithium battery operating temperature range updated
Rev 4	11/2016	<ul style="list-style-type: none">☞ Weight updated
Rev 5	04/2017	<ul style="list-style-type: none">☞ Added FCC Statement☞ Added Certifications in the specifications
Rev 6	03/2018	<ul style="list-style-type: none">☞ Added IP67 Certification



www.accent-systems.com

WHERE TO FIND US

Barcelona
Terra Alta, 1-3 (Pol. Ind. Can
Carner)
08211 Castellar del Vallès
Barcelona - Spain
Telf: (+34) 93.512.51.38

New York
1460 Broadway
New York, NY 10036, USA

SOCIAL

