

# iBKS Plus Datasheet



## ABSTRACT

iBKS Plus Technical Data

## AUDIENCE

This document is primarily focused for engineers or other users with a technical profile

## FEATURES

- Advertising **Beacon** Device
- **Bluetooth Low Energy**®
- Full **Eddystone** & **iBeacon** compatible
- 100% Configurable Parameters
- Firmware update **Over The Air** (OTA)
- Waterproof performance
- External button to enable/disable and configure with a status LED
- Provided with your own configuration (MOQ 50 units)
- Screws/ flanges/ sticker for deploying
- Additional optional sensors available

**Revision 2 | September 2016**

# Table of Contents

1. Specifications .....	2
2. iBKS Plus Mechanical Draws.....	3
3. Button Functionality .....	3
3.1 Turn ON iBKS Plus.....	4
3.2 Turn OFF iBKS Plus.....	5
4. Battery Life Estimation .....	6
4.1 Estimation Scope.....	6
4.2 Common Use Cases.....	6
4.3 Battery life estimation for iBKS Plus Alkaline.....	7
4.4 Battery life estimation for iBKS Plus Lithium .....	8
5. RX Power (dBm) vs Distance.....	9
Revision History .....	11

# 1. Specifications

This section contains electrical, mechanical and software specifications for iBKS Plus

<b>Dimensions</b>	84 x 84 x 24 mm	<b>Case material</b>	ABS
<b>Weight</b>	182g	<b>Case finish</b>	Matte white
<b>Core</b>	Nordic nRF51822	<b>Button material</b>	TPU
<b>Radio Protocol</b>	Bluetooth® Low Energy	<b>Button finish</b>	Matte black
<b>Distance Range</b>	Up to 100m	<b>Fixing method</b>	Double side sticker Screws Flanges
<b>Battery</b>	4 AA size	<b>Operating Temperature</b>	Related to battery type (see below)
<b>Optional Sensors</b>	Hall Accelerometer Temperature	<b>Storage Temperature</b>	Related to battery type (see below)
<b>Firmware Update</b>	OTA (Over The Air)	<b>Beacon Protocols</b>	iBeacon Eddystone: UID, URL, TLM & EID
<b>Idle Current Consumption</b>	3.5 to 3.8µA		

## Alkaline Battery

<b>Battery Type</b>	4 AA - 1.5V - 2700mAh	<b>Operating Temperature</b>	-20 to +54°C
<b>Total Capacity</b>	3V - 5400mAh	<b>Storage Temperature</b>	5 to 30°C

## Lithium Battery

<b>Battery Type</b>	4 AA - 3.6V - 2600mAh	<b>Operating Temperature</b>	-60 to +85°C
<b>Total Capacity</b>	3.6V - 10400mAh	<b>Storage Temperature</b>	5 to 30°C

## 2. iBKS Plus Mechanical Draws

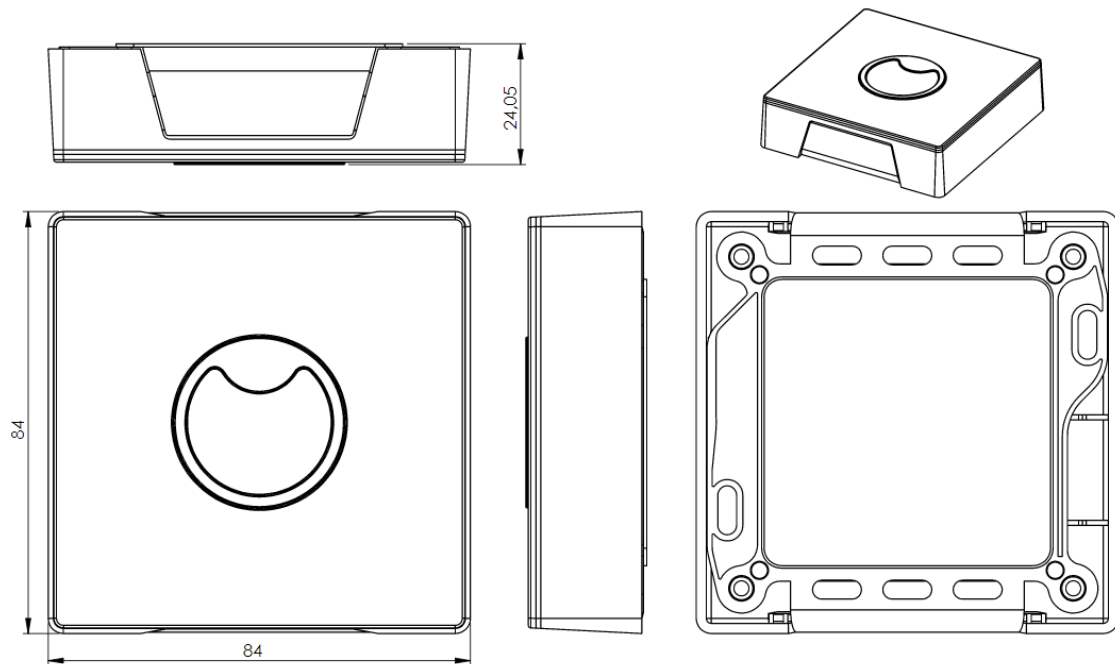

All dimensions in mm

## 3. Button Functionality

**IMPORTANT:**

This chapter applies from firmware version EDSTEID V5.2016.06.29.1 onwards.

By default, iBKS Plus comes from factory with batteries already installed. In order to avoid wasting energy, iBKS Plus is set to the off mode\*.

\*In the off mode, the Core is in sleep mode and the power consumption is rated to 3.5 $\mu$ A.

## 3.1 Turn ON iBKS Plus

**1** Push button once



**2** LED will start blinking for 30 seconds



- During these 30 seconds, the iBKS Plus is in connectable mode independently of the user mode configured. If the iBKS Plus is locked, the password will be also required to connect.

**3** After 30 seconds, the iBKS entries in the user set mode.

## 3.2 Turn OFF iBKS Plus

### 1 Push button once



### 2 LED will stay on for 3 seconds



### 3 The iBKS entries in the off mode

- In this status, the core is in sleep mode and will remain until the user turn it on again. The power consumption in this mode is rated to 3.5  $\mu$ A.

#### IMPORTANT:

If Eddystone EID frame is enabled, even the frame will not be advertised in this mode, the Core will wake up to keep the EID synchronization every defined period of time by the user through EID Rotation Period (K). In that case, the power consumption is rated to 3.8  $\mu$ A.

## 4. Battery Life Estimation

### IMPORTANT:

Battery life estimation applies from firmware version EDSTEID V5.2016.06.29.1 onwards.

**Notice all values shown in this chapter are just an estimation. Real battery life might differ depending on the environment where the iBKS Plus is placed.**

### 4.1 Estimation Scope

In order to estimate the battery life, the following configurable items have been considered:



























- Number of slots enabled
- Type of slot: iBeacon or Eddystone (UID, URL, TLM and EID)
- TX power defined for each slot
- Advertising period defined for each slot
- Beacon mode: connectable or non-connectable.

### 4.2 Common Use Cases

The common use cases shown in the table have been estimated under the following conditions:

- All the slots enabled advertise at the same TX power.
- All the slots enabled, except Eddystone Telemetry (TLM), have the same advertising period: 950ms.
- The advertising period for Eddystone TLM is set to 60s.
- The iBKS is in always non-connectable mode.
- EID Rotation Period (K) is set to 10 which means that every 17 minutes approximately a new ephemeral ID is calculated.



























## 4.3 Battery life estimation for iBKS Plus Alkaline

Slots Enabled	Tx Power (dBm)							
	-30	-20	-16	-12	-8	-4	0	+4
 iBeacon	91	91	90	88	88	87	84	77
 UID Eddystone	90	90	90	88	88	86	84	77
 URL Eddystone	90	90	90	88	88	86	84	77
 EID Eddystone	92	92	92	90	90	89	87	81
 iBeacon  TLM Eddystone	85	85	85	83	83	82	79	73
 iBeacon  URL Eddystone	69	69	68	66	66	64	61	55
 UID  TLM Eddystone Eddystone	85	85	84	83	83	81	79	73
 UID  URL Eddystone Eddystone	69	68	68	67	66	64	61	54
 URL  TLM Eddystone Eddystone	85	85	84	83	83	81	79	73
 EID  URL Eddystone Eddystone	70	70	69	67	67	66	63	56
 EID  TLM Eddystone Eddystone	92	87	86	86	85	84	81	76
 iBeacon  URL Eddystone	69	68	68	66	66	64	61	54
 TLM Eddystone								
 UID  URL Eddystone Eddystone	68	68	67	65	65	65	61	54
 TLM Eddystone								
 EID  URL Eddystone Eddystone	70	69	69	67	67	65	62	56
 TLM Eddystone								

Notes: Battery Life in months. Battery Capacity 4 x LR6 Alkaline: 5400mAh



## 4.4 Battery life estimation for iBKS Plus Lithium

Slots Enabled	Tx Power (dBm)							
	-30	-20	-16	-12	-8	-4	0	+4
 iBeacon	103	102	102	102	101	100	98	93
 UID Eddystone	102	102	102	101	101	100	98	93
 URL Eddystone	102	102	102	101	101	100	98	93
 EID Eddystone	104	104	103	103	102	101	100	96
  TLM Eddystone	99	99	99	98	97	97	95	90
  URL Eddystone	87	86	86	85	84	83	80	74
 UID  TLM Eddystone Eddystone	99	99	98	98	97	96	94	90
 UID  URL Eddystone Eddystone	86	86	86	85	84	83	80	74
 URL  TLM Eddystone Eddystone	99	99	98	98	97	96	94	90
 EID  URL Eddystone Eddystone	87	87	87	86	85	84	81	75
 EID  TLM Eddystone Eddystone	100	100	100	99	99	98	96	92
  URL Eddystone	86	86	86	85	84	83	80	74
 TLM Eddystone								
 UID  URL Eddystone Eddystone	86	86	85	85	84	82	80	73
 TLM Eddystone								
 EID  URL Eddystone Eddystone	87	87	86	86	85	84	81	75
 TLM Eddystone								

Notes: Battery Life in months. Battery Capacity 4 x LR6 Lithium: 10400mAh

## 5. RX Power (dBm) vs Distance

The following table and graph show the RX power received (dBm) in comparison with distance (m) for all configurable TX powers.

Distance (m)	TX Power (dBm)							
	-30	-20	-16	-12	-8	-4	0	+4
0	-52	-40	-38	-36	-34	-29	-26	-22
1	-90	-80	-78	-75	-73	-67	-59	-53
3	-95	-86	-81	-80	-79	-73	-67	-65
5	-99	-88	-86	-83	-81	-76	-73	-68
10	-102	-95	-88	-86	-84	-78	-75	-71
15		-97	-92	-91	-90	-88	-82	-78
20		-98	-94	-92	-91	-89	-85	-82
30		-99	-96	-93	-92	-91	-87	-84
40		-100	-98	-94	-94	-93	-89	-86
50		-102	-100	-97	-96	-95	-93	-90
60			-101	-98	-98	-97	-96	-91
70			-102	-101	-100	-99	-98	-92
80				-102	-101	-100	-98	-94
90					-102	-101	-99	-96
100						-102	-101	-100

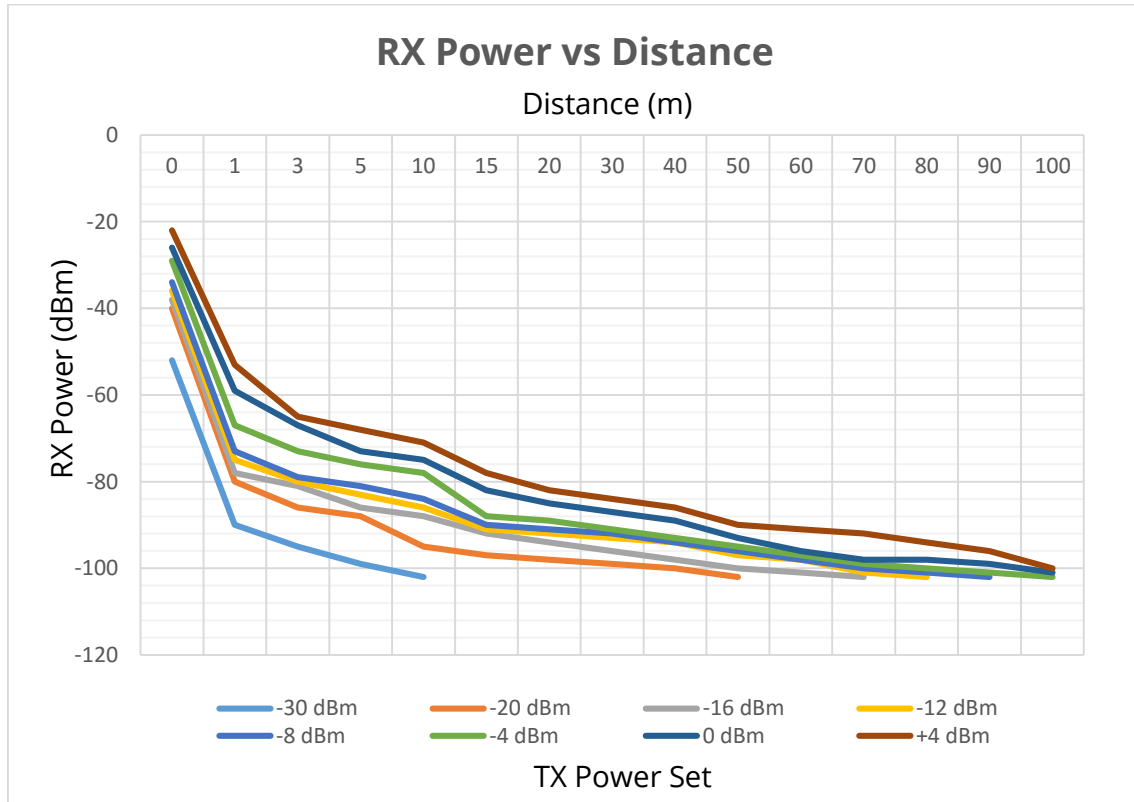

IMPORTANT:

This chapter applies from firmware version EDSTEID V5.2016.06.29.1 onwards.

**Notice all values shown in this chapter have been tested in an open field of a city. Depending on the environment where the iBKS Plus is placed these values might differ.**

## Revision History

The following revision history table summarizes changes contained in this document.

Revision Number	Revision Date	Description of Changes
Rev 0	10/2015	Initial Release
Rev 1	08/2016	<ul style="list-style-type: none"><li>☞ Design changed</li><li>☞ Specifications updated</li><li>☞ Added mechanical draws</li><li>☞ Added button functionality</li><li>☞ Added battery life estimation</li><li>☞ Added RX Power vs Distance</li></ul>
<b>Rev 2</b>	09/2016	<ul style="list-style-type: none"><li>☞ Battery life estimation values updated</li><li>☞ Batteries capacity values updated</li></ul>



[www.accent-systems.com](http://www.accent-systems.com)

**Accent Systems**

Office  
Avda. Francesc Macia 46-50, 7th Floor  
08208 Sabadell  
Barcelona - Spain

Factory  
Terra Alta, 1-3 (Pol. Ind. Can Carner)  
08211 Castellar del Vallès  
Barcelona - Spain